

Medium power transistor(-80V,-0.7A)

2SB1189

FEATURES

- High breakdown voltage, $BV_{CEO} = -80V$,
And high current, $I_C = -0.7A$.
- Complementary the 2SD1767.

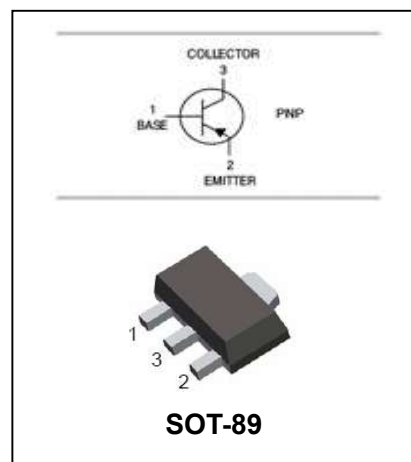

ORDERING INFORMATION

Type No.	Marking	Package Code
2SB1189	BDP/BDQ/BDR	SOT-89

MAXIMUM RATING @ $T_a = 25^\circ C$ unless otherwise specified

Symbol	Parameter	Value	Unit
V_{CBO}	Collector-Base Voltage	-80	V
V_{CEO}	Collector-Emitter Voltage	-80	V
V_{EBO}	Emitter-Base Voltage	-5	V
I_C	Collector Current	-0.7	A
P_C	Collector power dissipation	500	mW
T_j, T_{stg}	Junction and Storage Temperature	-55 to +150	$^\circ C$

Medium power transistor(-80V,-0.7A)

2SB1189

ELECTRICAL CHARACTERISTICS @ Ta=25°C unless otherwise specified

Parameter	Symbol	Test conditions	MIN	TYP	MAX	UNIT
Collector-base breakdown voltage	$V_{(BR)CBO}$	$I_C=-50\mu A, I_E=0$	-80			V
Collector-emitter breakdown voltage	$V_{(BR)CEO}$	$I_C=-2mA, I_B=0$	-80			V
Emitter-base breakdown voltage	$V_{(BR)EBO}$	$I_E=-50\mu A, I_C=0$	-5			V
Collector cut-off current	I_{CBO}	$V_{CB}=-50V, I_E=0$			-0.5	μA
Emitter cut-off current	I_{EBO}	$V_{EB}=-4V, I_C=0$			-0.5	μA
DC current gain	h_{FE}	$V_{CE}=-3V, I_C=-0.1A$	82		390	
Collector-emitter saturation voltage	$V_{CE(sat)}$	$I_C=-500mA, I_B=-50mA$		-0.2	-0.4	V
Transition frequency	f_T	$V_{CE}=-10V, I_E=-50mA, f=100MHz$		100		MHz
Output Capacitance	C_{obo}	$V_{CB}=-10V, f=1.0MHz, I_E=0$		14	20	pF

CLASSIFICATION h_{FE}

Rank	P	Q	R
Range	82-180	120-270	180-390
Marking	BDP	BDQ	BDR

TYPICAL CHARACTERISTICS @ Ta=25°C unless otherwise specified

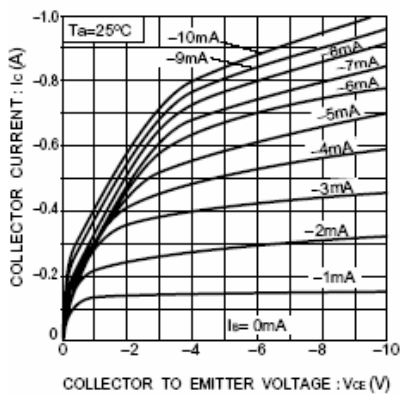

Fig.1 Ground emitter output characteristics

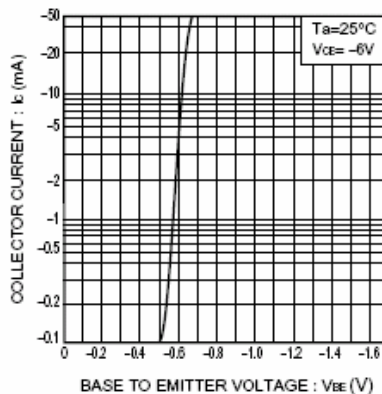

Fig.2 Ground emitter propagation characteristics

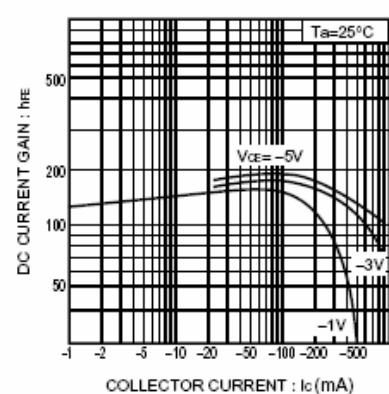

Fig.3 DC current gain vs. collector current

Medium power transistor(-80V,-0.7A)

2SB1189

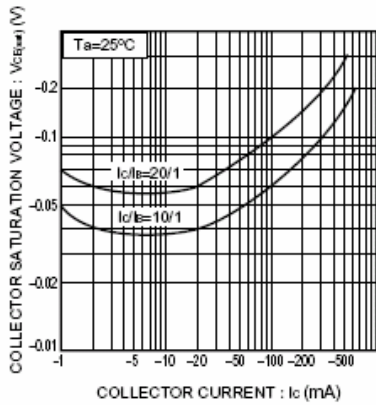

Fig.4 Collector-emitter saturation voltage vs. collector current

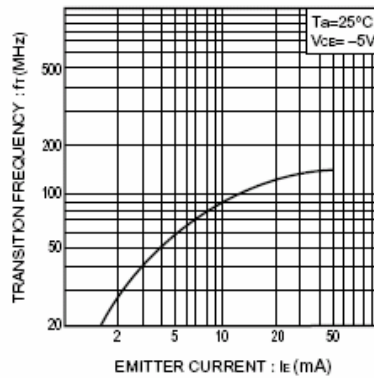

Fig.5 Gain bandwidth product vs. emitter current

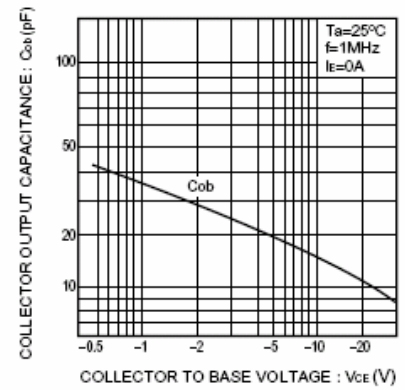

Fig.6 Collector output capacitance vs. collector-base voltage

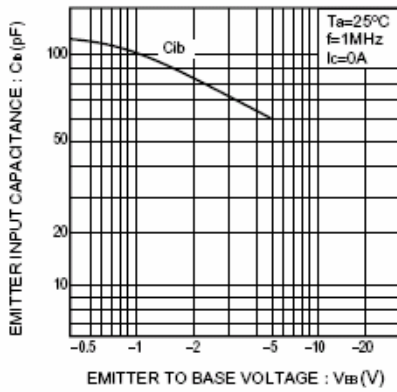

Fig.7 Emitter input capacitance vs. emitter-base voltage

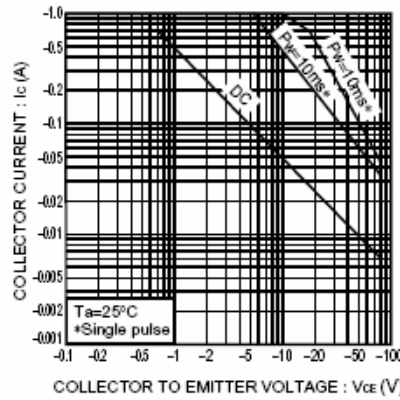

Fig.8 Safe operating area (2SB1189)

Medium power transistor(-80V,-0.7A)

2SB1189

PACKAGE OUTLINE

Plastic surface mounted package

SOT-89

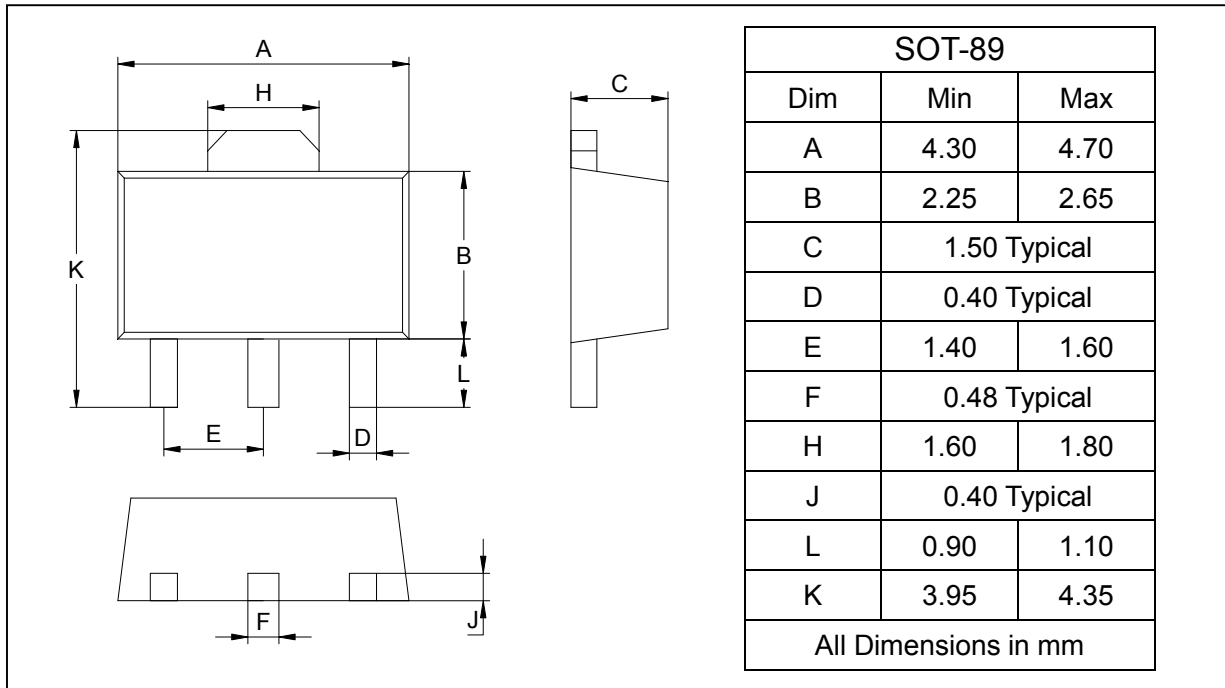

SOLDERING FOOTPRINT

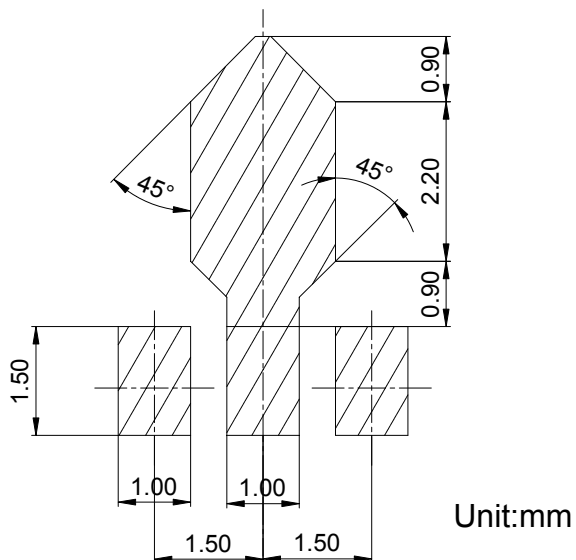

PACKAGE INFORMATION

Device	Package	Shipping
2SB1189	SOT-89	1000/Tape&Reel