

Small Signal MOSFET Transistor

2N7002T

FEATURES

- Low on-resistance.
- Low gate threshold voltage.
- Low input capacitance.
- Fast switching speed.
- Low input/output leakage.

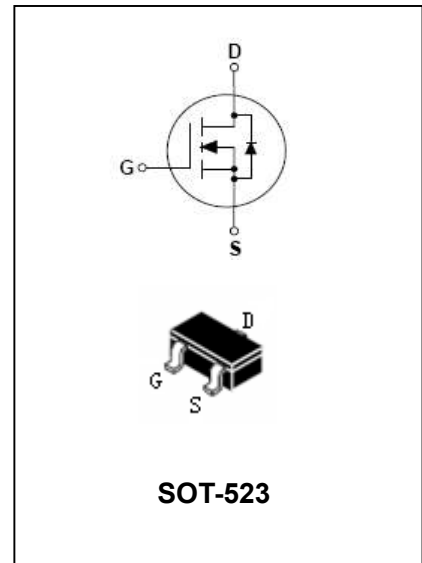

APPLICATIONS

- N-channel enhancement mode effect transistor.
- Switching application.

ORDERING INFORMATION

Type No.	Marking	Package Code
2N7002T	72	SOT-523

MAXIMUM RATING @ Ta=25°C unless otherwise specified

Symbol	Parameter	Value	Units
V _{DSS}	Drain-Source voltage	60	V
V _{DGR}	Drain-Gate voltage(R _{GS} ≤1MΩ)	60	V
V _{GSS}	Gate -Source voltage - continuous	± 20	V
	-Non Repetitive (t _p <50μs)	± 40	
I _D	Maximum Drain current -continuous	115	mA
	-Pulsed	800	
P _D	Power Dissipation	150	mW
R _{θJA}	Thermal resistance,Junction-to-Ambient	833	°C/W
T _J , T _{stg}	Junction and Storage Temperature	-55 to +150	°C

Small Signal MOSFET Transistor

2N7002T

ELECTRICAL CHARACTERISTICS @ Ta=25°C unless otherwise specified

Parameter	Symbol	Test conditions	MIN	TYP	MAX	UNIT
Drain-Source Breakdown Voltage	$V_{(BR)DSS}$	$V_{GS}=0V, I_D=10\mu A$	60			V
Gate Threshold Voltage	$V_{GS(th)}$	$V_{DS}=V_{GS}, I_D=250\mu A$	1		2	
Gate-body Leakage	I_{GSS}	$V_{DS}=0V, V_{GS}=20V$ $V_{DS}=0V, V_{GS}=-20V$			10 -10	nA
Zero Gate Voltage Drain Current	I_{DSS}	$V_{DS}=60V, V_{GS}=0V$			1	μA
		$V_{DS}=60V, V_{GS}=0V, T_j=125^\circ C$			500	
On-state Drain Current	$I_{D(on)}$	$V_{GS}=10V, V_{DS}=7.5V$	0.5	1.0		A
Forward transconductance	g_{FS}	$V_{DS}=10V, I_D=200mA$	80			mS
Static drain-Source on-resistance	$R_{DS(on)}$	$V_{GS}=5.0V, I_D=50mA$		2	7.5	Ω
Input capacitance	C_{ISS}	$V_{DS}=25V, V_{GS}=0V, f=1.0MHz$		22	50	pF
Output capacitance	C_{OSS}			11	25	
Reverse transfer capacitance	C_{RSS}			2	5	
Turn-On Delay Time	$t_{D(on)}$	$V_{DD}=30V, I_D=0.2A,$ $R_L=150\Omega, V_{GS}=10V,$ $R_{GEN}=25\Omega$		7.0	20	ns
Turn-Off Delay Time	$t_{D(off)}$			11	20	ns

Small Signal MOSFET Transistor

2N7002T

TYPICAL CHARACTERISTICS @ Ta=25°C unless otherwise specified

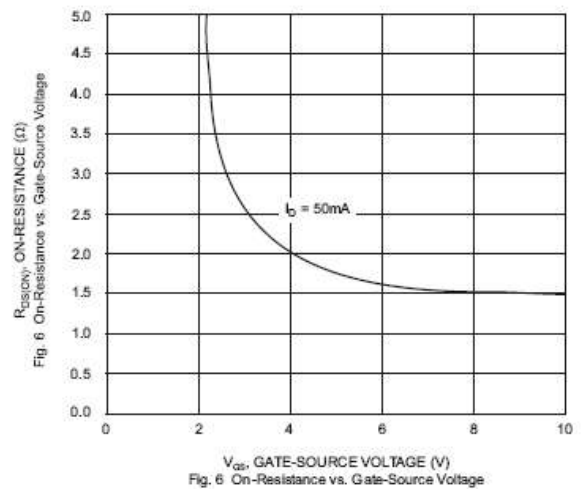
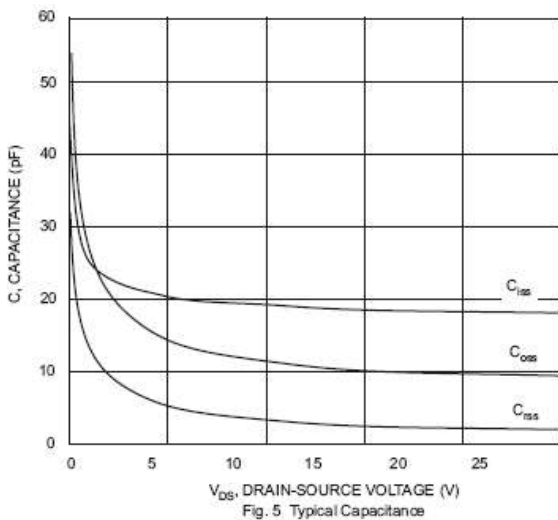
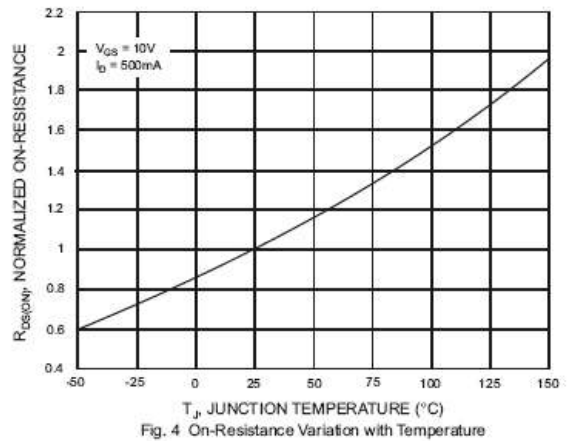
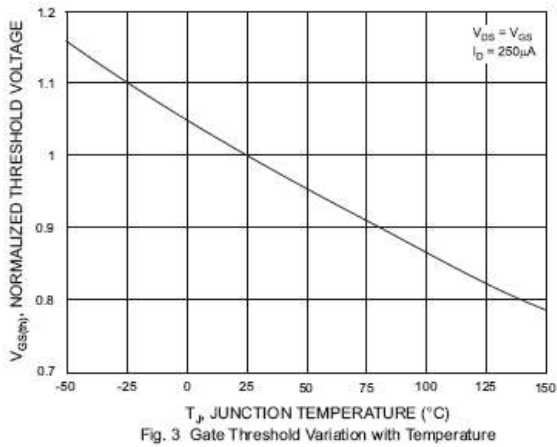
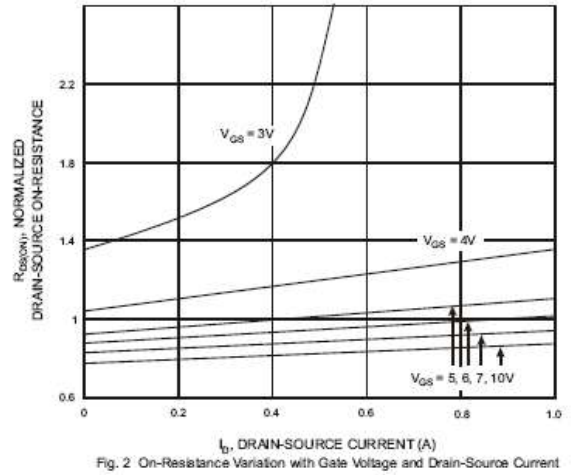
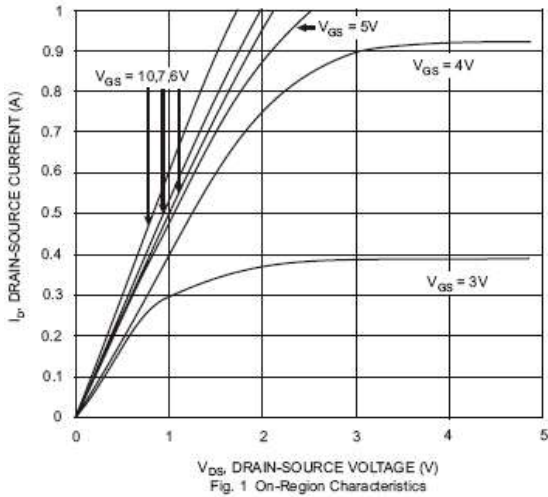

Small Signal MOSFET Transistor

2N7002T

PACKAGE OUTLINE

Plastic surface mounted package

SOT-523

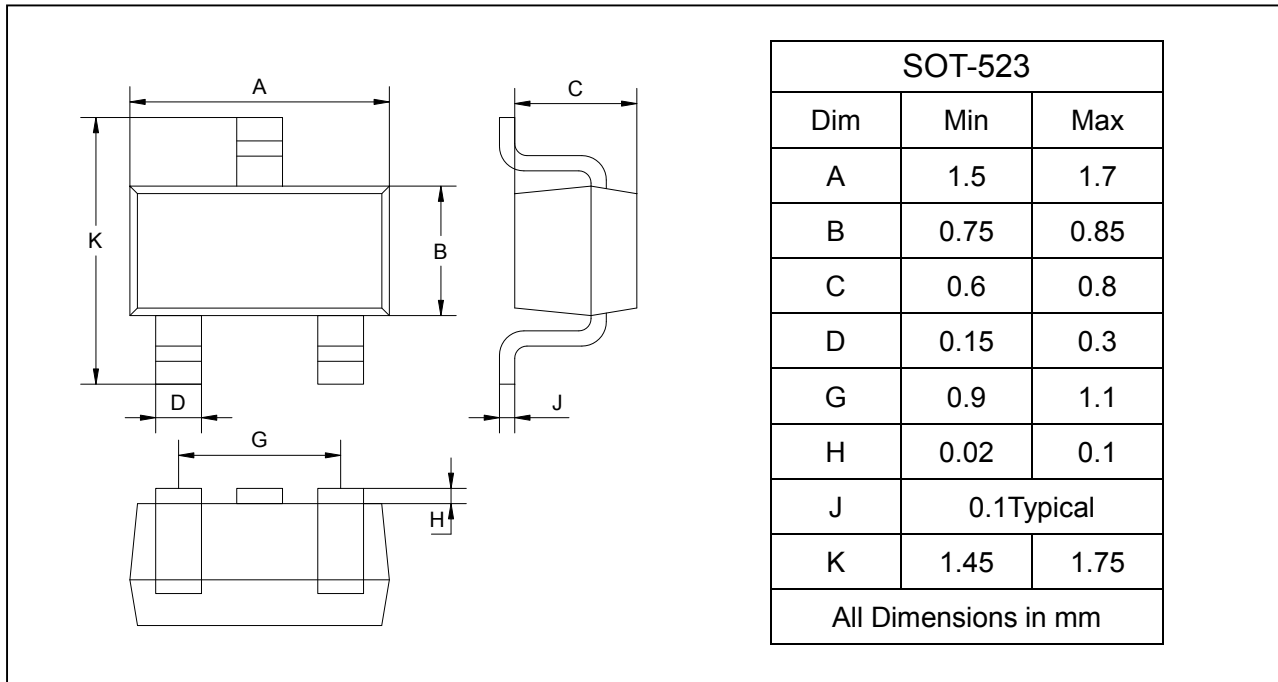

SOLDERING FOOTPRINT

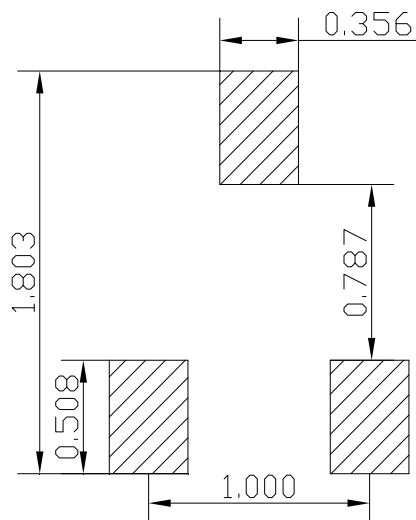

Unit : mm

PACKAGE INFORMATION

Device	Package	Shipping
2N7002T	SOT-523	3000/Tape&Reel