

N-Channel Enhancement Mode Field Effect Transistor

2N7002

FEATURES

- High Density Cell Design For Low $R_{DS(ON)}$.
- Voltage Controlled Small Signal Switch.
- Rugged and Reliable.
- High Saturation Current Capability.
- MSL 1



APPLICATIONS

- N-channel enhancement mode effect transistor.
- Switching application.

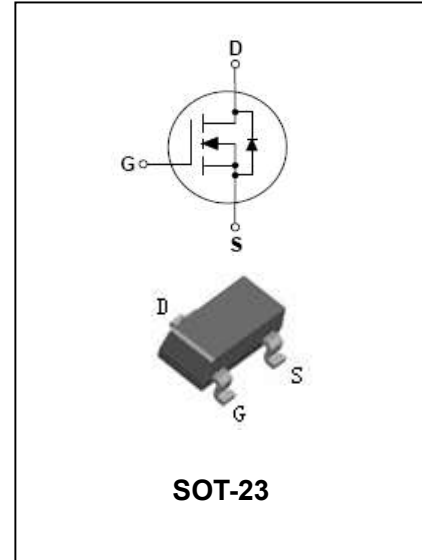

ORDERING INFORMATION

Type No.	Marking	Package Code
2N7002	7002	SOT-23

MAXIMUM RATING @ $T_a=25^\circ\text{C}$ unless otherwise specified

Symbol	Parameter	Value	Units
V_{DSS}	Drain-Source voltage	60	V
V_{DGR}	Drain-Gate voltage($R_{GS}\leq 1\text{M}\Omega$)	60	V
V_{GSS}	Gate -Source voltage - continuous -Non Repetitive ($t_p<50\mu\text{s}$)	± 20 ± 40	V
I_D	Maximum Drain current -continuous -Pulsed	115 800	mA
P_D	Power Dissipation	200	mW
$R_{\theta JA}$	Thermal resistance,Junction-to-Ambient	625	$^\circ\text{C}/\text{W}$
T_J, T_{stg}	Junction and Storage Temperature	-50 to +150	$^\circ\text{C}$

N-Channel Enhancement Mode Field Effect Transistor

2N7002

ELECTRICAL CHARACTERISTICS @ Ta=25°C unless otherwise specified

Parameter	Symbol	Test conditions	MIN	TYP	MAX	UNIT
Drain-Source Breakdown Voltage	$V_{(BR)DSS}$	$V_{GS}=0V, I_D=10\mu A$	60	70	-	V
Gate Threshold Voltage	$V_{GS(th)}$	$V_{DS}=V_{GS}, I_D=250\mu A$	1	-	2.0	
Gate-body Leakage	I_{GSS}	Forward $V_{DS}=0V, V_{GS}=20V$	-	-	1	uA
		Reverse $V_{DS}=0V, V_{GS}=-20V$	-	-	-1	
Zero Gate Voltage Drain Current	I_{DSS}	$V_{DS}=60V, V_{GS}=0V$	-	-	1	μA
		$V_{DS}=60V, V_{GS}=0V, T_j=125^\circ C$	-	-	500	
On-state Drain Current	$I_{D(ON)}$	$V_{GS}=10V, V_{DS}\geq 2.0V_{DS(ON)}$	0.5	1.0	-	A
Drain-Source on-voltage	$V_{DS(ON)}$	$V_{GS}=10V, I_D=500mA$	-	0.6	3.75	V
		$V_{GS}=5V, I_D=50mA$	-	0.09	1.5	
Forward transconductance	g_{FS}	$V_{DS}=10, I_D=200mA$	80	-	-	mS
Static drain-Source on-resistance	$R_{DS(ON)}$	$V_{GS}=5.0V, I_D=50mA$	-	3.2	7.5	Ω
		$V_{GS}=10V, I_D=500mA, T_j=100^\circ C$	-	4.4	13.5	
On-state drain current	$I_{D(ON)}$	$V_{GS}=10V, V_{DS}=7.5V$	0.5	1.0	-	A
Drain-Source diode forward voltage	V_{SD}	$V_{GS}=0V, I_S=115mA$	-	0.88	1.5	V
Input capacitance	C_{ISS}	$V_{DS}=25V, V_{GS}=0V, f=1.0MHz$	-	20	50	pF
Output capacitance	C_{OSS}		-	11	25	
Reverse transfer capacitance	C_{RSS}		-	4	5	
Turn-On Delay Time	$t_{D(ON)}$	$V_{DD} = 30V, I_D = 0.2A,$ $R_L = 150\Omega, V_{GS} = 10V,$	-	-	20	ns
Turn-Off Delay Time	$t_{D(OFF)}$	$R_{GEN} = 25\Omega$	-	-	20	ns

TYPICAL CHARACTERISTICS @ Ta=25°C unless otherwise specified

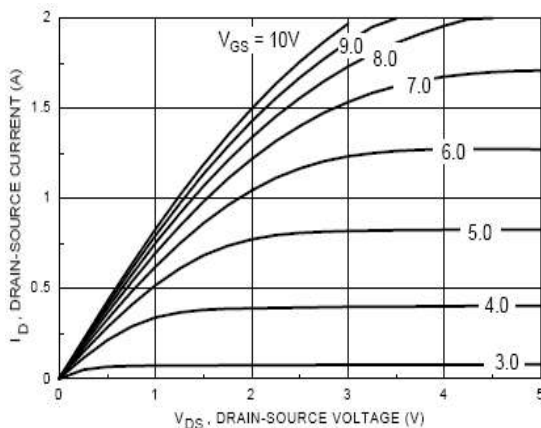

Figure 1. On-Region Characteristics

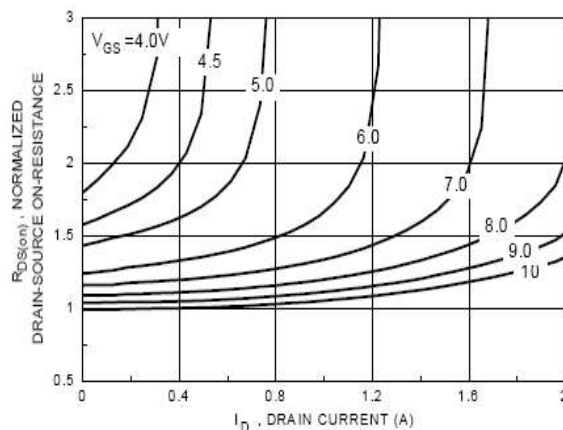

Figure 2. On-Resistance Variation with Gate Voltage and Drain Current

N-Channel Enhancement Mode Field Effect Transistor

2N7002

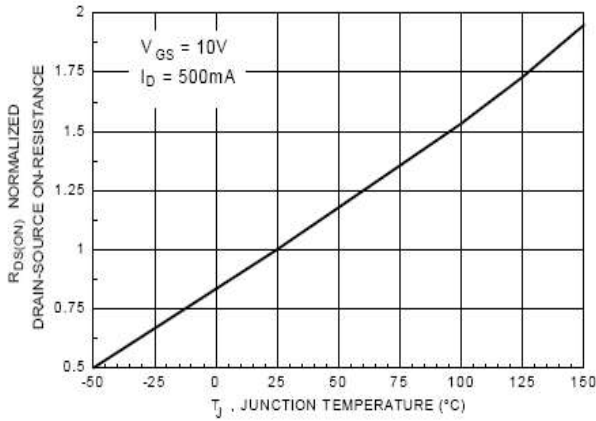

Figure 3. On-Resistance Variation with Temperature

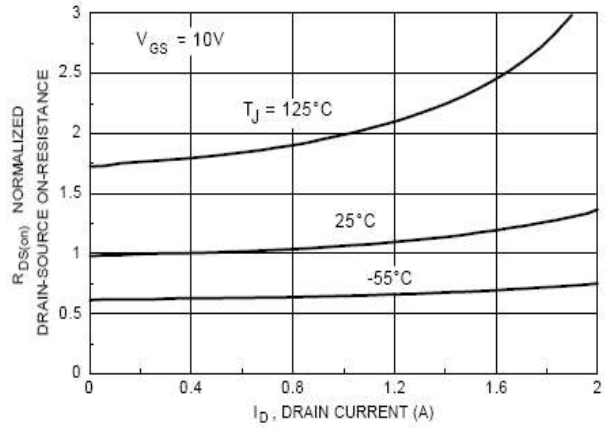

Figure 4. On-Resistance Variation with Drain Current and Temperature

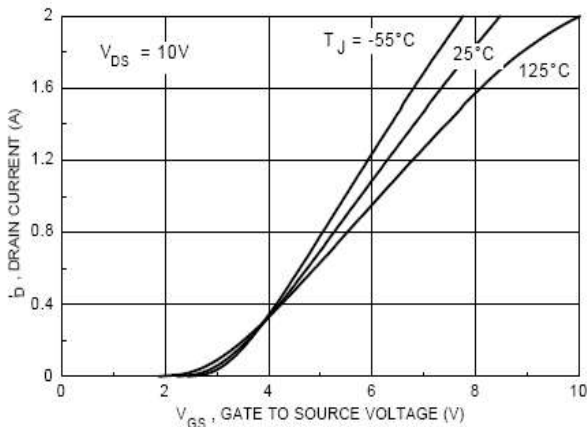

Figure 5. Transfer Characteristics

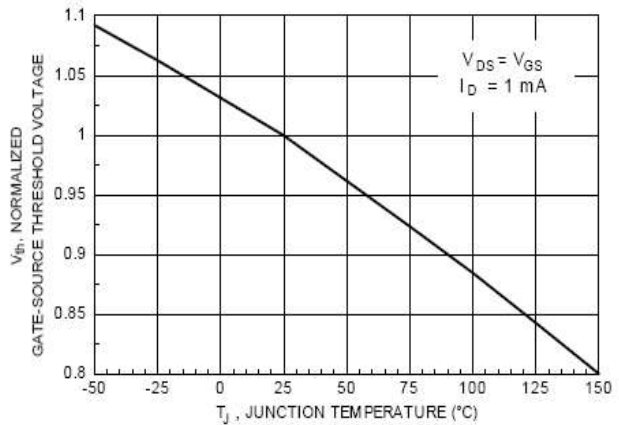

Figure 6. Gate Threshold Variation with Temperature

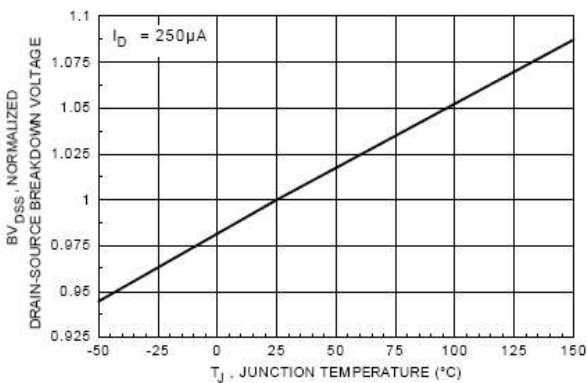

Figure 7. Breakdown Voltage Variation with Temperature

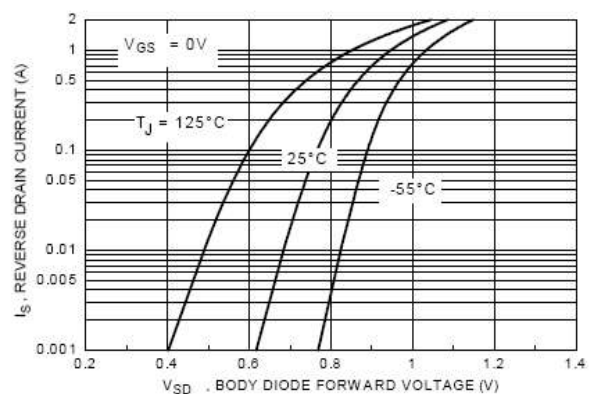

Figure 8. Body Diode Forward Voltage Variation with Temperature

N-Channel Enhancement Mode Field Effect Transistor

2N7002

PACKAGE OUTLINE

Plastic surface mounted package

SOT-23

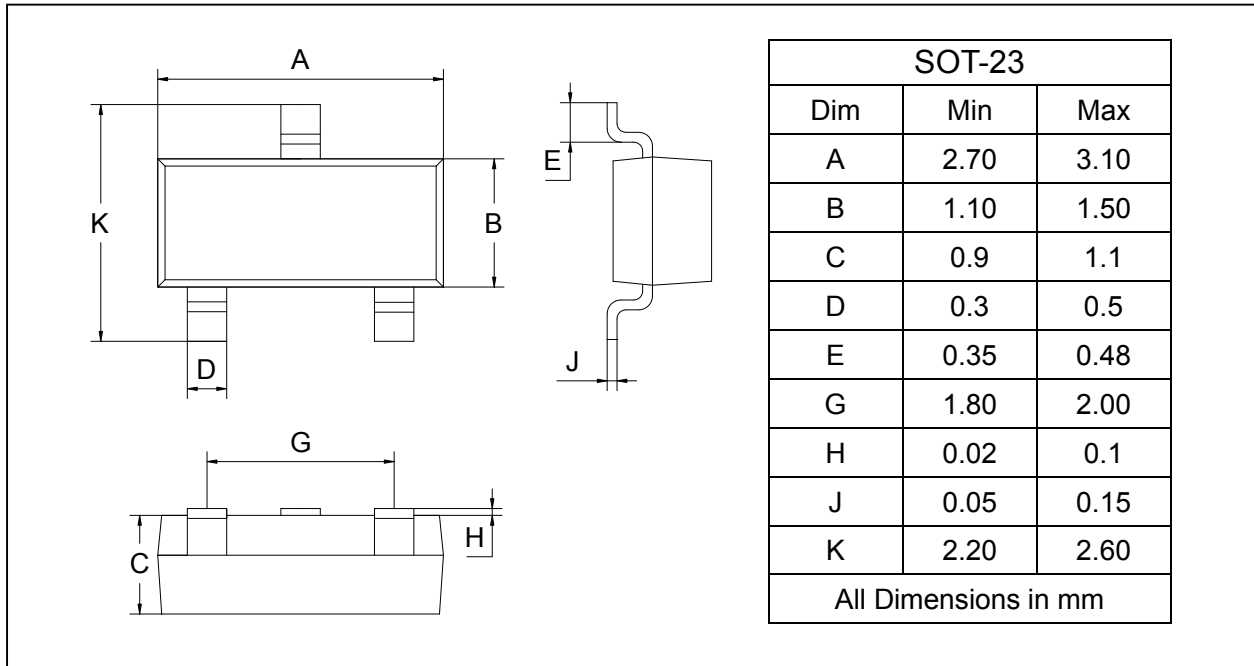

SOLDERING FOOTPRINT

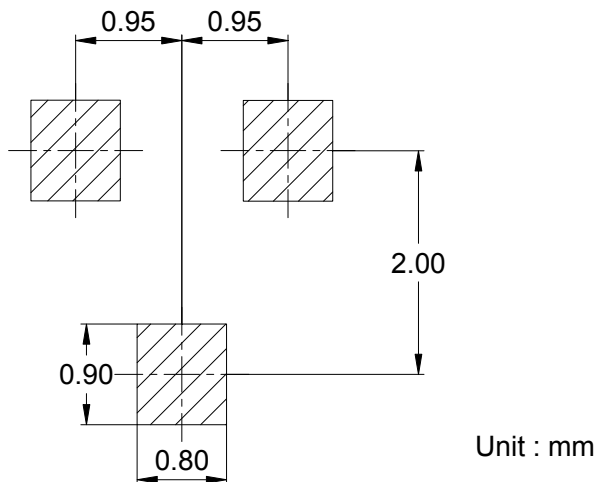

PACKAGE INFORMATION

Device	Package	Shipping
2N7002	SOT-23	3000/Tape&Reel